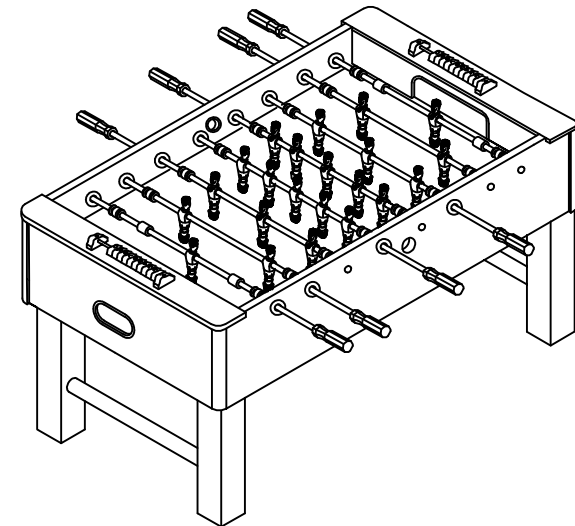

TABLE SOCCER



ASSEMBLY INSTRUCTIONS

PEGASI



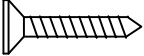
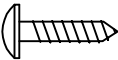
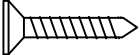

PARTS IDENTIFIER

HARDWARE

	DESCRIPTION	QTY. REQUIRED
	H1 1/4"x2-5/8" BOLT	8
	H2 1/4"x1-1/8" BOLT	16
	H3 1/4" WASHER,	24
	H4 1" FLAT HEAD PHILLIPS SCREW	4
	H5 1/2" ROUND HEAD PHILLIPS SCREW	20
	H7 3/4" FLAT HEAD PHILLIPS SCREW	8

ACCESSORIES

QTY







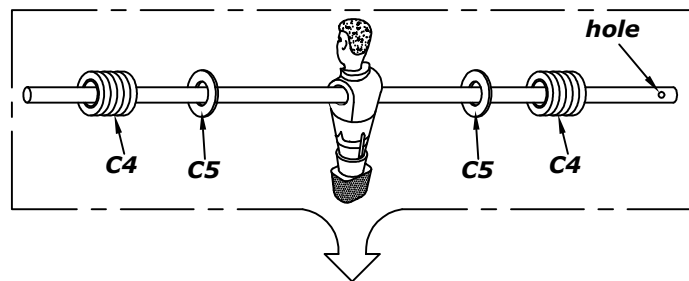

	A1 SOCCER BALL	2
	A2 TOOL	1

ASSEMBLY INSTRUCTIONS

SOCCKER TABLE ASSEMBLY





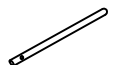





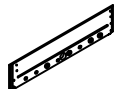



WARNING: TWO ADULTS NEEDED TO ASSEMBLE SOCCER TABLE



	R1	5 HOME PLAYERS ROD	1
	R2	3 HOME PLAYERS ROD	1
	R3	2 HOME PLAYERS ROD	1
	R4	1 HOME PLAYERS ROD	1
	R5	5 AWAY PLAYERS ROD	1
	R6	3 AWAY PLAYERS ROD	1
	R7	2 AWAY PLAYERS ROD	1
	R8	1 AWAY PLAYERS ROD	1
	R9	Solid Rod (INSERT THE PLAYERS ROD)	8







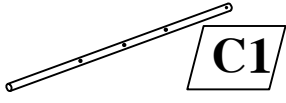
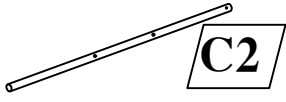
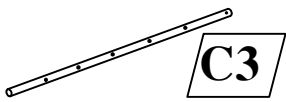

PARTS IDENTIFIER

ASSEMBLY PARTS

	DESCRIPTION	QTY
	P1 SIDE PANEL	2
	P2 END PANEL	2
	P3 PLAYING FIELD	1
	P4A LEG A	2
	P4B LEG B	2
	P5 PLAYFIELD SUPPORT BRACE	2
	P6 SUPPORT BRACKET	4
	P7 HANDLE	8
	P8 SLIDE SCORER	2
	P9 PLASTIC NUT	8
	P10 PLASTIC BOLT A	8
	P11 PLASTIC BOLT B	8
	P12 CROSS BAR	2
	P13 CORNER	4

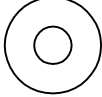
PARTS IDENTIFIER

REPLACEMENT PARTS

	DESCRIPTION	QTY
	C1 3 PLAYER ROD	4
	C2 2 PLAYER ROD	2
	C3 5 PLAYER ROD	2
red point 	C4 Rod Springs (A)	8
	C5 Rod Springs (B)	8
	C6 BOLT	52
	C7 PLASTIC ROD WASHERS	8
	C8 AWAY MEN	11
	C9 HOME MEN	11
	C10 STOP RING	4

ASSEMBLY INSTRUCTIONS

SOCCKER TABLE ASSEMBLY

- AS SHOWN IN **figure 5**, INSERT THE PLAYERS ROD **R1~ R8** THROUGH THE HOLE OF THE TWE SIDE PANELS FROM THE INSIDE TO THE OUTSIDE IN POWER.
- INSERT THE RODS **R9** IN THE PLASTIC BOLT **A P10**, BE SURE THE HOLE OF ROD MUST FACE THE HOLE OF **P11**, PUT THE PLASTIC BOLT **B P11** INTO THE HOLE OF THE ROD AND PLASTIC BOLT **A P10**, THEN INSERT THE ASSEMBLED ROD IN THE HOLE OF SIDE PANEL, TIGHTEN THE PLASTIC NUT **P9** AS SHOWN IN **figure 5**.
* Do not over tighten **P9**.
- SLIDE THE HANDLES **P7** ONTO THE ENDS OF THE RODS, ATTACH THE TWO SETS OF SLIDE SCORER **P8** TO THE END OF TABLE WITH SCREWS **H4**.

ASSEMBLY INSTRUCTIONS

SOCCKER TABLE ASSEMBLY

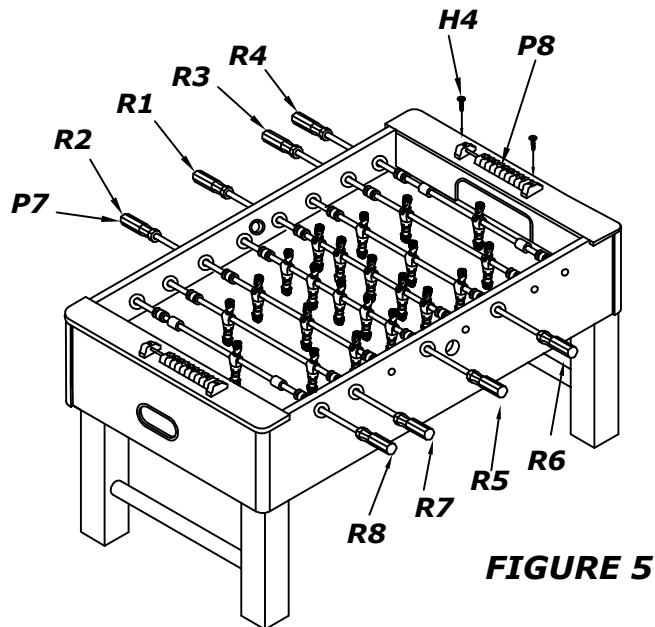
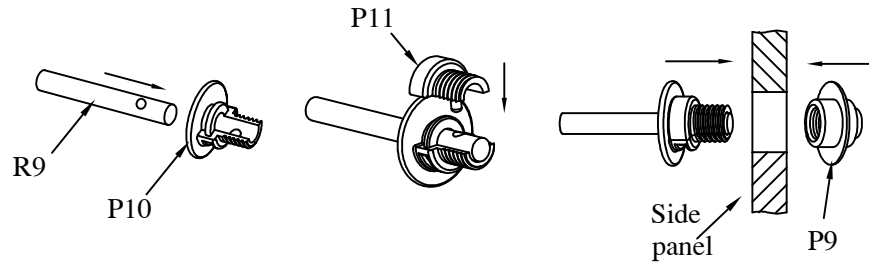
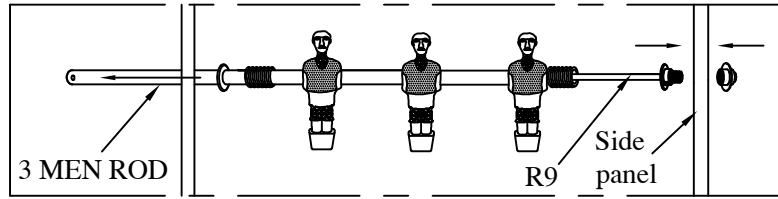

FIGURE 5

ASSEMBLY INSTRUCTIONS

SOCCKER TABLE ASSEMBLY

1. CUT CORNERS OF THE BOX AND PLACE IT ON THE FLOOR TO PROTECT THE PARTS AS THE UNIT IS BEING ASSEMBLED. PLACE SIDE PANELS **P1** UPSIDE DOWN AS SHOWN IN **figure 1**. (THE ROUND BALL ENTRY HOLE WILL BE CLOSEST TO THE FLOOR.)
2. INSERT PLAYFIELD **P3** INTO THE GROOVE ON THE SIDE PANELS **P1** WITH GRAPHICS FACING DOWN. SEE **FIGURE 1**.

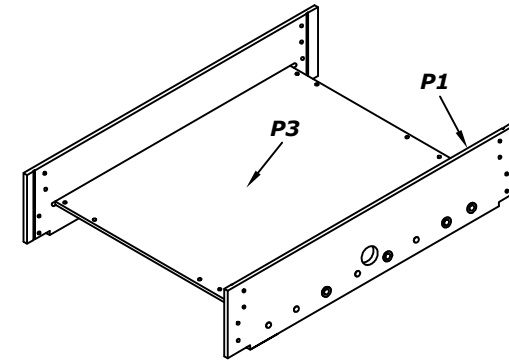

FIGURE 1

ASSEMBLY INSTRUCTIONS

SOCCKER TABLE ASSEMBLY

WARNING: TWO ADULTS NEEDED TO ASSEMBLE SOCCER TABLE

3. INSERT THE CORNER TO THE ENDS AND SINDE PANELS. ATTACH THE TWO END PANELS **P2** TO THE SIDE PANELS **P1** WITH BOLTS **H1** AND WASHERS **H3** AS SHOWN IN **FIGURE 2**.
4. ATTACH THE CORNER IN THE ENDS AS WITH SCREW **H5** SHOWN IN **figure 2**.

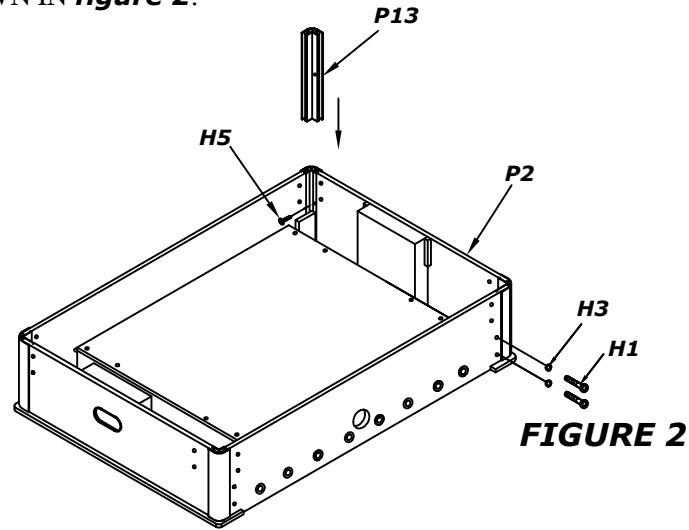

5. ATTACH PLAY FIELD WITH SCREWS **H7** AS SHOWN IN **figure 3**.

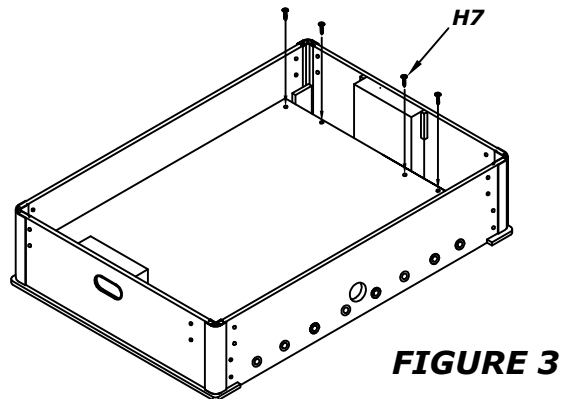

ASSEMBLY INSTRUCTIONS

SOCCKER TABLE ASSEMBLY

WARNING: TWO ADULTS NEEDED TO ASSEMBLE SOCCER TABLE

6. PLACE THE PLAYFIELD SUPORT BRACES ON THE BOTTOM OF THE PLAYFIELD. ATTATCH THE BRACES USING BRACKETS **P6** AND SCREWS **H5**.
7. INSERT CROSS BAR **P12** INTO LEGS AS SHOWN IN **FIGURE 4**. ATTACH THE LEGS **P4&P4B** AS SHOWN IN **figure 4** . THE LEGS ARE ATTACHED WITH BOLTS **H2** AND WASHERS **H3**.

WARNING

This step requires two adults!
Very carefully turn the table over , Be careful!

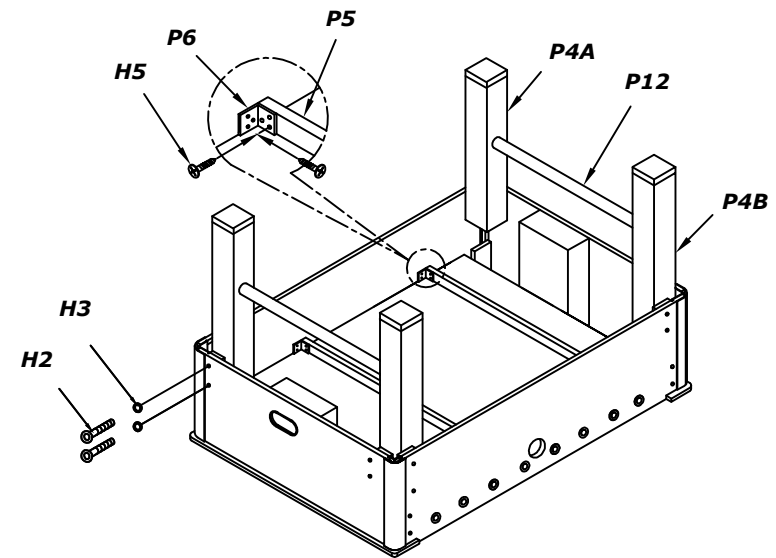

FIGURE 4